

C-511-GT

KNC



FEATURES

- 150 lbs. [68 kg] weight capacity
- Quick Release Hanger System for easy installation
- Nylon wheels and precision ball bearings provide smooth and quiet door operation
- Adjustable in-track stops
- Cycle tested for up to 150,000 cycles without fail
- ADA Compliant (Barrier-free) design
- Anodized or powder-coated finishes also available
- For 1 3/4 in [44.5 mm] thick doors

COMPLETE 2 DOOR KIT BREAKDOWN



1 - C-500 Double Track
x length based on kit size (e.g. 72 in [1829 mm] kit for 36 in [914 mm] wide door)



4 - C-411 Quick Release Hangers
complete with screws



4 - CDC-411 Catch/Stops
complete with screws

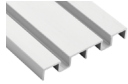

1 - C-202 Double Groove Guide Threshold
x length based on kit size (e.g. 36 in [914 mm] guide channel for 72 in [1829 mm] kit)



4 - C-200 Guides
complete with screws

OPTIONAL

Door Locks & Pulls



Add-On Products



C-521 Fascia x 1
x track length

C-521 Fascia x 2
x track length

Customer Name

Job No./Name

Date

Provided By

Notes

KN Crowder

1220 Burloak Drive, Burlington, Ontario, Canada, L7L 6B3
T. 1-866-999-1562 customerservice@kncrowder.com kncrowder.com
© 2020-2024 K.N. Crowder Mfg. Inc. All Rights Reserved.

C-511-GT



COMPLETE ELEVATION VIEW

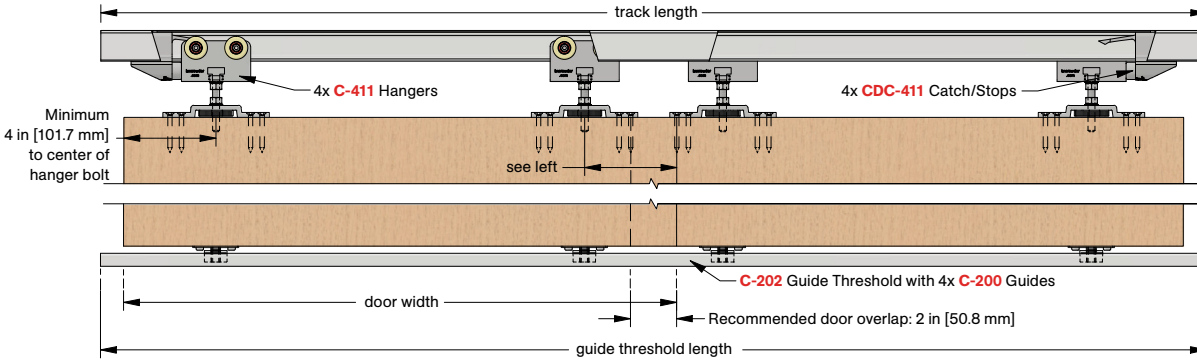

PRODUCT DIMENSIONS

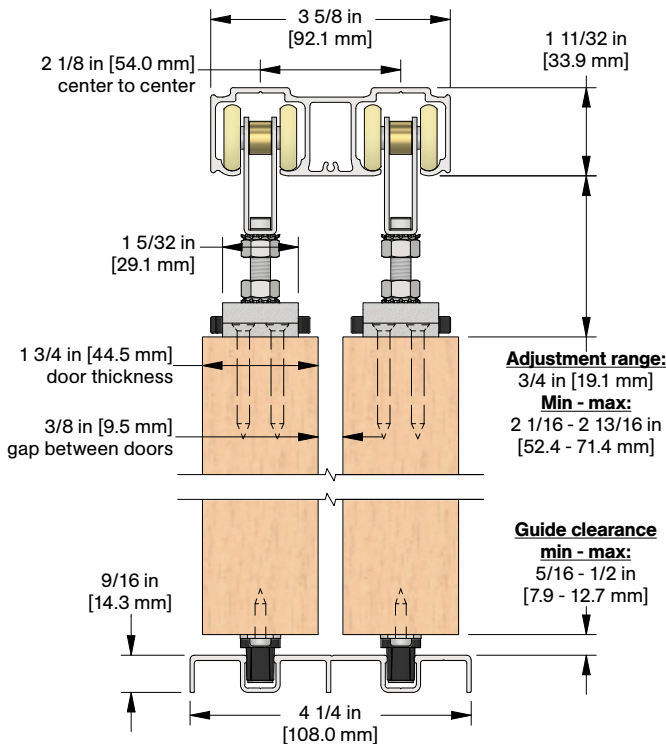

Optional C-521 Snap-on Fascia, illustrated as solid black profile

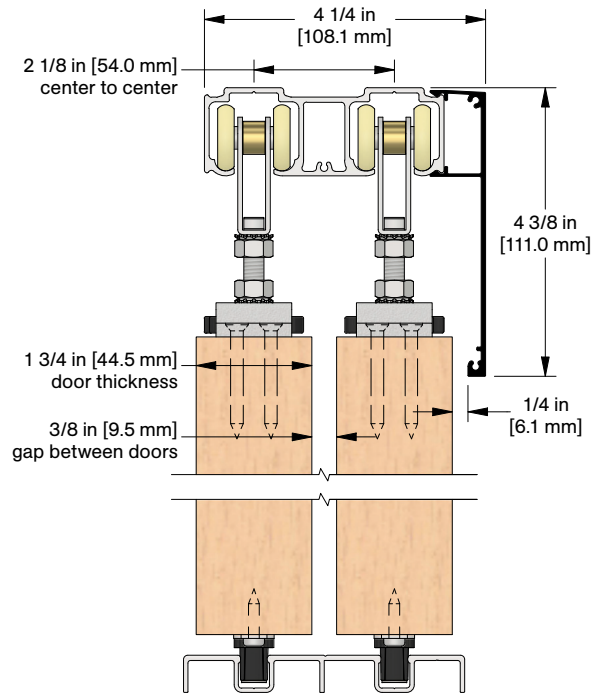

Installation
Instructions



Customer Name

Job No./Name

Date

Provided By

Notes