

# C-80L-CT Security Lockset

Installation Instructions



## Specifications

**Case:** Heavy gauge wrought

**Armor Front:** Brass, bronze, stainless

**Dead Bolt:** 1/2 in [12.7 mm] thick x 5/8 in [15.9 mm] high x 1 in [25.4 mm] throw

**Pull:** 1/4 in [6.4 mm] thick x 1 1/2 in [38.1 mm] high x 7/8 in [22.2 mm] swingout

**Thumb Turn Hub:** 3/16 in [4.8 mm] on the diamond

**Cam:** See details on right

**Door Thickness:** 1 3/8 in [34.9 mm] to 1 3/4 in [44.5 mm]

## Cam Required: B520-233

### Dimensions

W = 1.000 in [25.4 mm]

X = 0.232 in [5.9 mm]

Y = 0.729 in [18.5 mm]

Z = 0.694 in [17.6 mm]

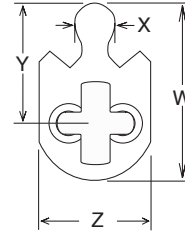

**Not to scale**

## Included Components

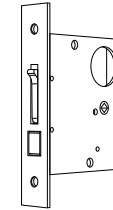

**C-80L**  
Lock and Edge Pull Body

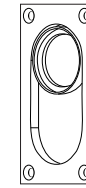

**C-80C**  
Cylinder Flush Pull

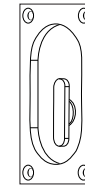

**C-80T**  
Thumb Turn Flush Pull

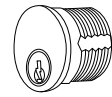

### Cylinder

1-5/32 in Diameter hole x 1 in Depth.  
5-PIN Schlage "C"  
Key Way (will **not** sit flush with door)

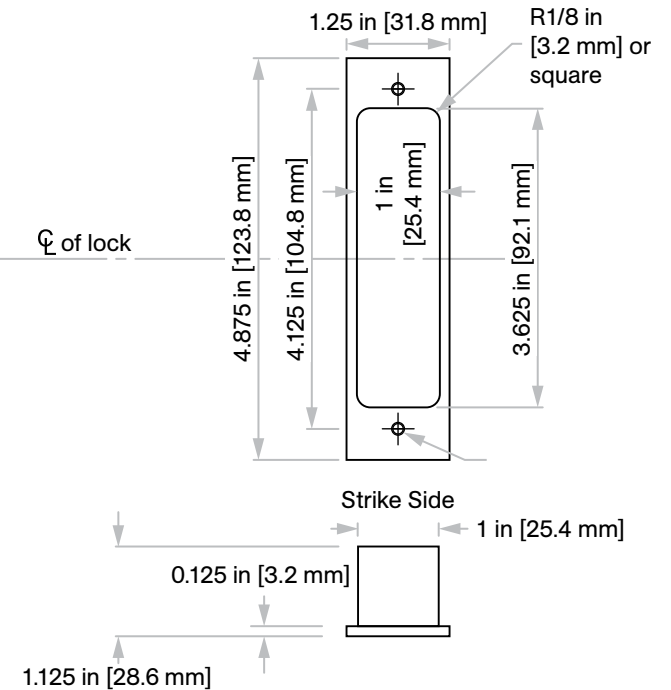
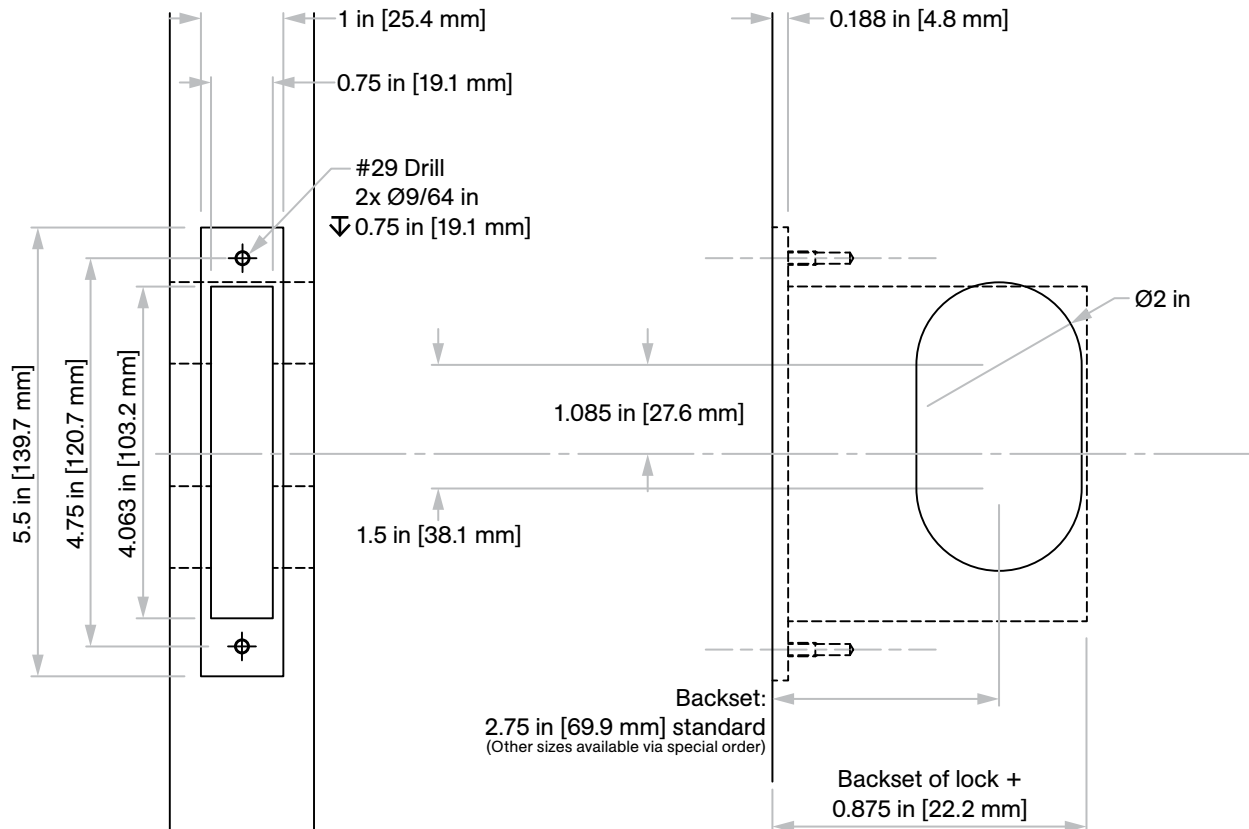

**Note:** Cylinder will **not** sit flush on 1 3/8 in [34.9 mm] doors